



Instruction Manual MixGenizer Series

Instruction Manual High Pressure Micromix Homogenizer

Catalog No. MixGenizer





1. Open-box Inspection

Check whether there is any packing damage. Refer to the packing slip for the integrity of the product.

2. Product Introduction

2.1 Brief Introduction

MixGenizer is a homogenizer specially for mixing and homogenizing the sample fluids from two or more inlet ports. The two streams are injected into the Genizer ultra high pressure dual pumps from the inlet reservoir and mix homogeneously at the diamond mixing chamber where the fluids pass through the fixed micro-channels and experience high shears and strong impacts. It can be used for laboratory preparation of liposomes, nanosuspensions, microemulsions, lipid microsphere, nanoprecipitations, nanoemulsions, nanocrystals, infusion solutions, fine chemical reaction and etc.

2.2 SPECIFICATIONS

Catalog No.	MixGenizer-30K
Max. Flow Rate	100mL/min
Min. Sample	1mL
Max. Pressure	30,000psi
Dimensions(cm)	85×50×35
Weight	58 kg
Max. Temp.	80°C (176°F)
Power	220V/110V
Cleaning	Flush to clean



Instruction Manual MixGenizer Series

Application	Nano emulsion, Fat emulsion, Liposome, Cell disruption, Nano dispersion, Deagglomeration, Nano precipitations
Features	Notable shear rate; Powerful micromix; Reliable repeatability; Guaranteed scalability

STANDARD FEATURES

Parts	Y-type Diamond Mixing Chamber
Control System	High pressure programming control systems [®] : Touch Screen, Speed control, Auto stop control by volume, time, pressure or temperature, settable volume control as small as 1mL, display of flow rate and time, overload protection
Pressure Gauge	Digital display on the touch screen
Inlet Type	1/4" HP coupling
Outlet Type	1/4" HP coupling
Inlet Speed	0-100mL/min±0.1mL/min
Mixing Accuracy	1%
Mixing Arrange	25%-100%
Feed Reservoir	20mL Syringe or S/S Cylinder
Collector Reservoir	20mL Syringe or S/S Cylinder
Product Material	316L Stainless Steel, Tungsten Carbide, Viton, Teflon
Material Standard	Pharmaceutical Grade, FDA, GMP
Warranty	1 year against any manufacturing defects

OPTION FEATURES

Parts	High pressure extruders, Y-type diamond mixing chamber with cooling, Heat exchanger
-------	---

Control System	Gradient Mixing, three or four component
Detector	Pressure gauge, Pressure transducer up to 8 optional, Temperature transducer up to 8 optional
Outlet Type	Tri-Clamp or Luer
Feed Reservoir	20mL, 50mL, 100mL, 200mL Syringe, 300mL, 500mL S/S Cylinder, Jacketed Glass Cylinder or Online
Collector Reservoir	20mL, 50mL, 100mL, 200mL Syringe, 300mL, 500mL S/S Cylinder, Jacketed Glass Cylinder or Online
Cylinder	Titanium High Pressure Cylinder (Resistant to strong acid and base)

3. Safety Instructions:

Operating the MixGenizer homogenizer involves handling samples at ultra high pressure. Therefore, the operation instructions must be well noted to avoid any personal injury or equipment damage result from ignoring the instructions or improper operations. DO NOT proceed until the operator fully read and understand the instructions listed in this chapter. Also, the personal shield is recommended during the operation, and the high pressure homogenizer is highly recommended to be operated in the shielded hood or space.

Instructions of "attention", "warning", "danger"

 **Attention:** Indicate the correct procedures and practices for operation and maintenance, to avoid damage to the equipment or other properties.

 **Warning:** Potential Danger. Correct procedures and practices need to be followed to avoid personal injury.

 **Danger:** The improper handling could cause hazardous condition,

such as serious personal injuries, damage to the equipment or even loss of life.

 **Warning:** The equipment or the components cannot be changed without authorization.

 **Warning:** It's necessary to completely read the user manual before operating the MixGenizer high pressure micromix homogenizer. The operator should be familiar with all the functions and control of this system.

 **Warning:** Please wear the proper individual protective gear when operating the MixGenizer homogenizer.

 **Warning:** Do not exceed the rated range. The MixGenizer homogenizer has designed maximum working pressure. Once exceeding, it would cause the equipment damage or personal injury.

 **Warning:** Do not screw up the firmware or move the equipment when the equipment is running or is under pressure.

 **Warning:** Do not use the broken component and replace it in time.

 **Warning:** The working pressure of this system should not exceed the maximum pressure of the rated component of this system. A pressure gauge can be installed in the system for checking the pressure condition of the system anytime.

 **Warning:** DO NOT point the inlet and outlet of high pressure

devices and equipments supplied by Genizer, including high pressure homogenizer, extruder, interaction chamber and valve, to any personnel and object which may induce the safety issue and property loss. The user and buyer should completely responsible for the violation of the clause and recommendation besides any other unsafe practices.

 **Warning:** Handle the equipment gently and do not put heavy things on the equipment.

 **Attention:** Keep the MixGenizer high pressure micromix homogenizer far away from the open fire and high temperature. The overheated environment would damage the sealing element, hosepipe and parts of the electric appliance components. The performance of the homogenizer will be influenced if the ambient temperature is higher than 60°C.

 **Danger:** The parts cannot be fixed only by the force of close-fitting. It could cause personal injuries by popping when the system pressure is too high.

 **Warning:** MixGenizer homogenizer should be maintained by qualified technicians. The user should be responsible for any improper maintenance.

 **Warning:** Use original parts to replace worn or damaged parts. Replacement with non-original parts will not be warranted.

4. Preparation

4.1 Make sure all connectors and hoses, electric wiring are in correct position. The rated pressure class of connectors and hoses should be followed, and the power-supply wiring should use the rated voltage and current.

4.2 The tightness degree of all thread connections should in moderate, not too loose or too tight.

4.3 Make sure all pipe fittings are connected properly to the outlet and inlet, which should not exceed the load of MixGenizer homogenizer.

4.4 The medium must be compatible with 316L stainless steel. Please consult with the manufacturer for details if you are not sure about the medium property. The following is the medium that can be used:

- Distilled Water
- Soluble oil (water-in-oil emulsion)
- Petroleum
- Alcohol
- Diester
- Acetone
- Silicone Oil
- Lipids
- Surfactants
- Other organic solvent
- Strong Acids and Base  **Titanium cylinder needed**

 **Attention:** The large area of corrosion damage of MixGenizer homogenizer caused by improper use of medium is not covered in the warranty.

5. Installation

MixGenizer series are high pressure micromix homogenizer equipments operated on the touch screen and controlled intelligently by PLC. The power supply for the whole set of the equipment is 220V/110V. The homogenizer should be installed according to the part drawing in the Components List.

 **Warning:** Fail to follow the chapter 5 might lead to personal injuries or damage to the equipment.

5.1 Placement of the Homogenizer

The equipment is heavy and should be placed on a stable platform. The equipment has non-slip foot-pads which do not need other fixing methods. The equipment requires extra space for safety and convenient operation.

5.2 Assembly of the Homogenizer

Most of the components of this equipment have been assembled before leaving factory. Some peripherals with different joint pipes according to the special requirements of users should be assembled by operator. For details, please refer to the component detailed parts drawing of *Components List* for assembling.



Figure 1

- 1) Please refer the assembled drawing to Figure 1.
- 2) Remain two-three circles of threads when screw the collar into the tubing as indicated in the Figure 2.

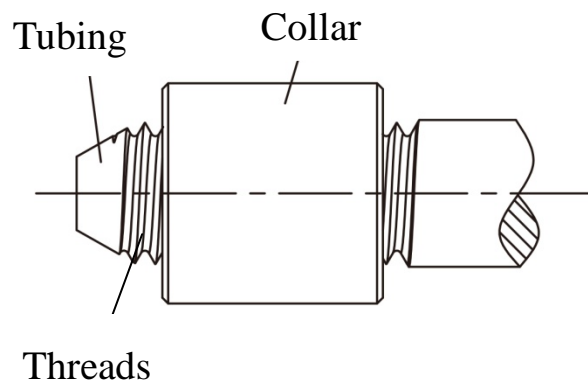

Figure 2

- 3) When installing the high pressure outlet connection, please pay attention to the installation direction of this high pressure connection.

5.3 Disassembly of the Plunger Seal

Regular replacement of the plunger seals is necessary when the seal parts is worn out. Use the supplied S/S disassemble tool to separate the high pressure cylinder of the homogenizer as indicated in Figure 3.

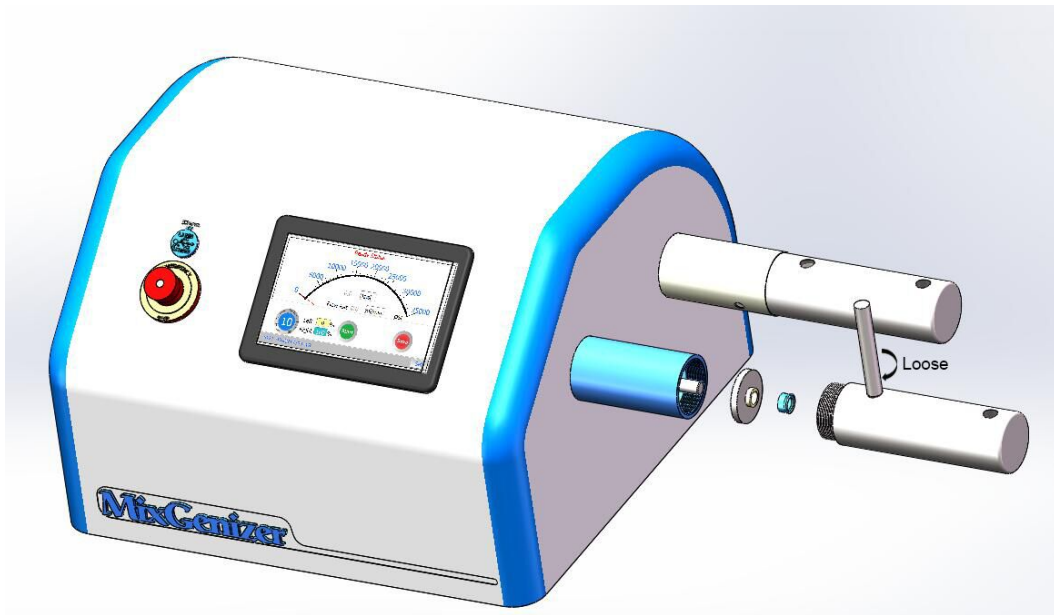

Figure 3

⚠ Warning: Before any disassemble or assemble procedure, please TURN OFF the MixGenizer first, then remove all the high pressure components from the S/S cylinder, including the DIXCs, heat exchanger, priming valve, fittings, inlet reservoir and other connections.

Below shows the plunger seal disassemble steps:

- First, screw the plugs① into the open ends of high pressure cylinder.
- Then, stand the cylinder upright to fill the center with some water②.
- After that, insert the supplied disassemble rod③ into the center cavity.
- Push the rod way down ④with bare hands until the S/S gasket and seal unit pop out and separate from the cylinder.

Inspect the plunger seal, and replace a new set if there is any sign of wear on it.

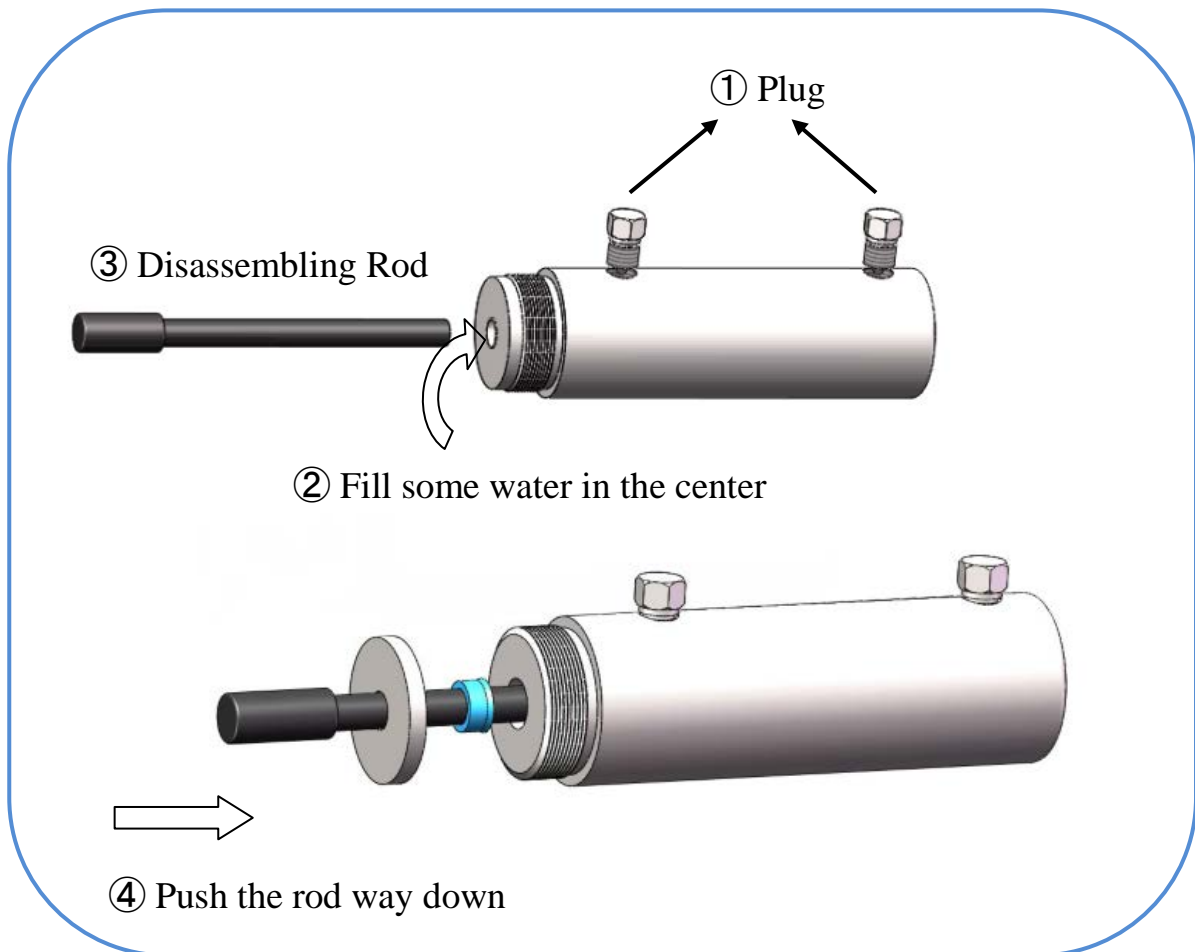

Figure 4

5.4 Assembly of the Plunger Seal

As shown in the Figure 5, for assembling the plunger seal, first screw tight the supplied assemble tool⑤ onto the cylinder. Then, insert the replaced UHMW-PE plunger seal⑥ into the center of the assemble tool **(NOTE: the small O-ring should face up)**. Last, lightly push the supplied assemble rod⑦ with the palm until the seal unit is inside the pump body. Remove all the tools to finish the assemble procedure of the plunger seal

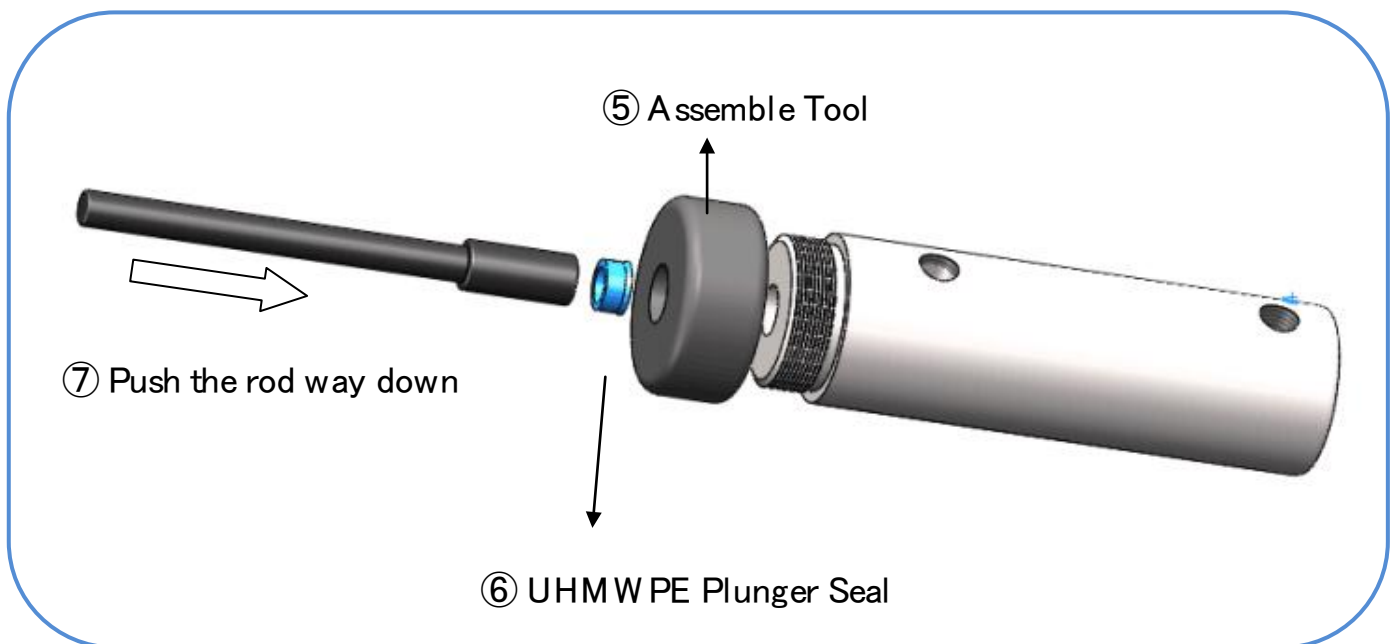
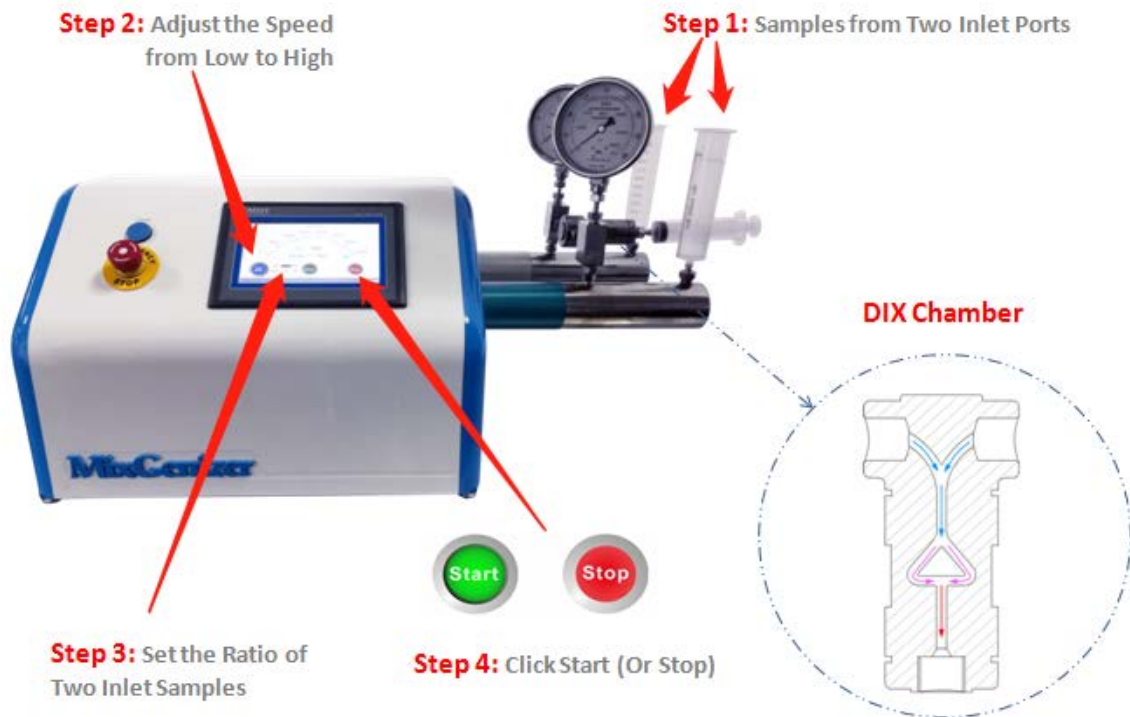

Figure 5

6. Operation

4 Easy Steps to Run MixGenizer



6.1 Operation Instruction

1) Initialization Stage of the System

First, connect to the electrical outlet; when the red power light is on, switch on the power at the left of the MixGenizer homogenizer. Once the touch screen of the homogenizer is started, all the indicator lights at the top right corner of the touch screen will be lit on, and the touch screen will show the initialization picture as following:



2) The display of the touch screen has three indicator lights on its top right corner. From left to right the three indicator lights are: RUN, the PLC indicator light; COM, the communication light; PWR, the power indicator light of the touch screen. Then machine is ready when all the lights are lit on. Otherwise, inspection is needed and the equipment cannot be started until the malfunction is resolved.

6.2 User Operation Interface

1) A loading progress bar will be shown when initialization. After loading, the touch screen will enter the user operation interface as following:

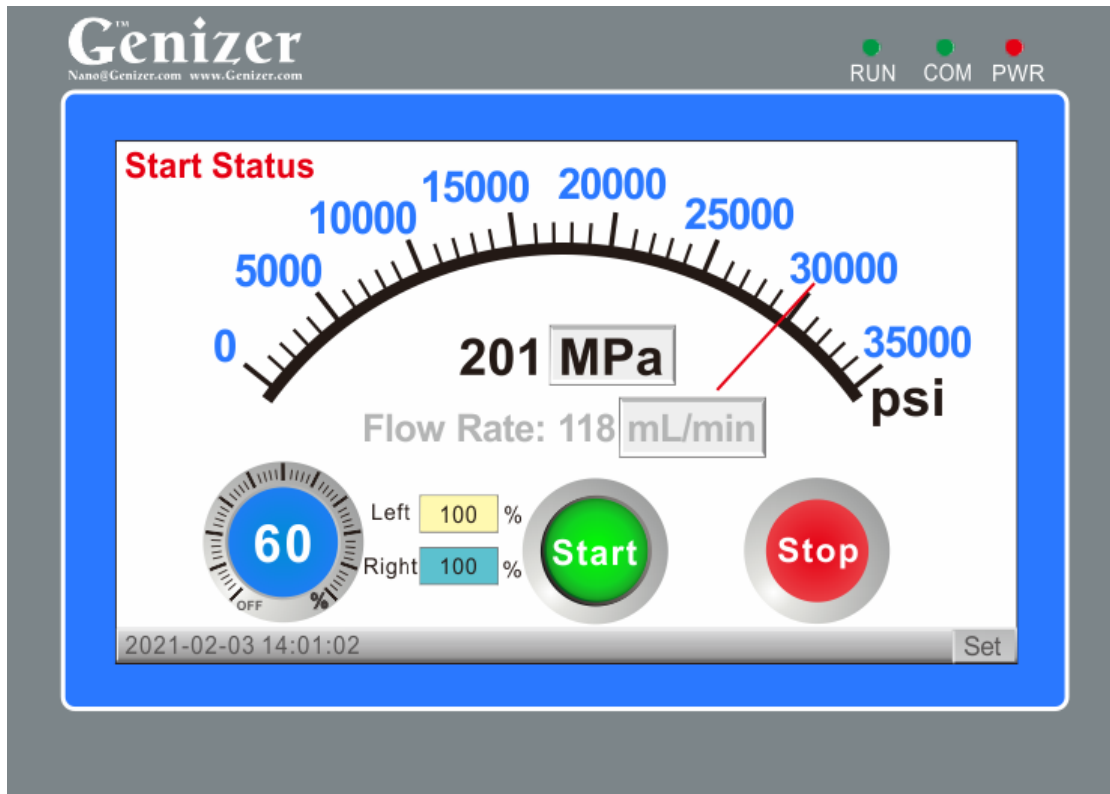

2) Digital pressure gauge: it indicates the pressure of the testing material.

3) Pressure value: it indicates the pressure value. And the pressure unit can be converted mutually among kPsi, MPa and Bar when the pressure unit option is clicked.

4) Flow rate: it indicates the flow rate of the homogenizer and the unit of the flow rate can be converted mutually among mL/min, L/hr and Gal/hr.

5) Power rate: it can be adjusted to reach the pressure value as needed according to the requirement of the user.

6) Left & Right: user can set the mixing ratio of two inlet samples.

7) Start button: when it is clicked, the homogenizer will start running.

8) Stop button: when it is clicked, the homogenizer will stop running.

If any special situations, please press the emergency stop button for the emergency stop. For releasing the emergency stop, turn the emergency button clockwise to pop the emergency knob out.

9) The parameter setting is mainly divided to the customer setup and the factory setup.



6.3 Selection Interface for the Customer Setup & Factory Setup

When clicking "Set" in the user operation interface, the selection interface of the customer setup and the factory setup will be shown.

(Attention: Correct password is needed before entering the factory setup

interface)

The parameter-setting interface has these options: Customer Setup, Factory Setup, Pressure-Time Record, User Guide and Back option.

1) Click “Customer Setup” and then enter the interface of the customer setup.

2) Click “Factory Setup”, input the correct password and then enter the interface of the factory setup.

3) Click “Pressure-Time Record” for checking and reviewing the records of the recent 20 strokes.

4) Click “User Guide” for the application introduction.

5) Click “Back” option and then return to the previous menu.

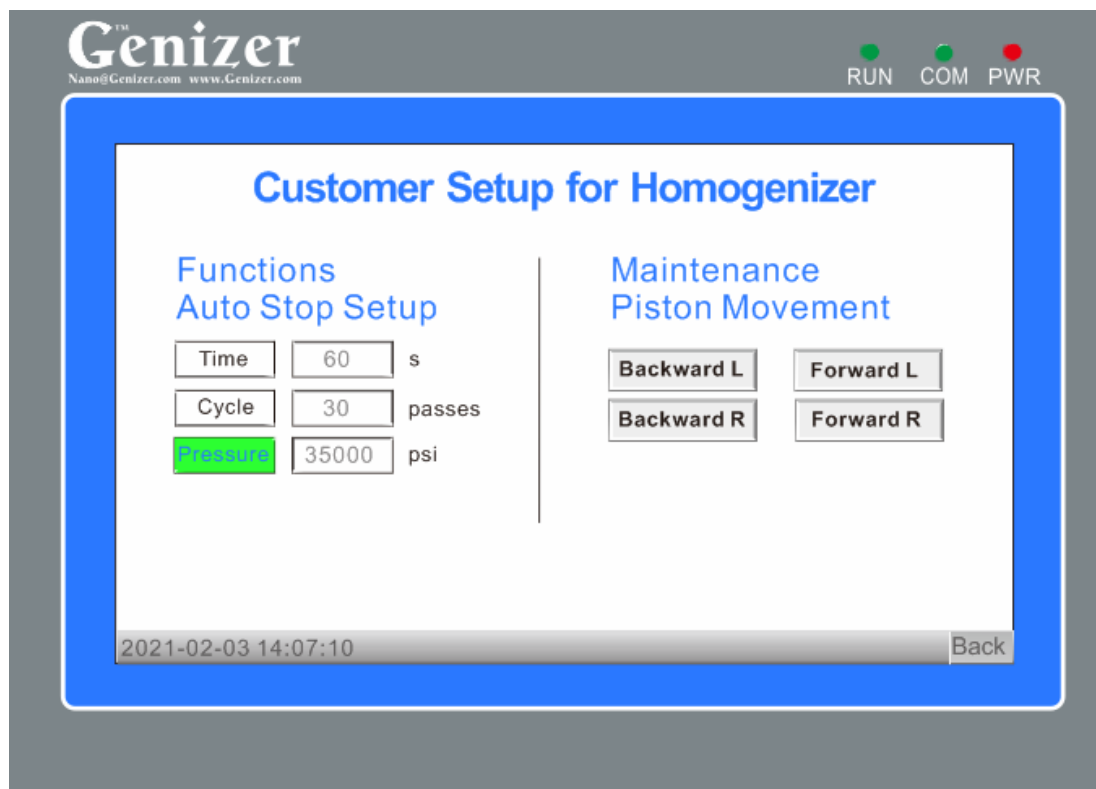

6.4 Parameter Interface of Customer Setup

In this interface, the user can set the running time (default as 1800 seconds); running passes; safe pressure (once exceeding, the equipment will stop immediately); date; the manual forward option and the manual backward option; and the back button for returning to the previous menu.

1)Time: set the timing and click “Time” to start the timing function, and then press the “Start” button in the user operation interface to run the homogenizer. The equipment will stop automatically when the timing time is ended.

2)Pressure: set the pressure value and click “Pressure” to open the safe pressure function, and then press the “Start” button in the operation interface. The system will compare the actual running pressure with the setting safe pressure. When the actual pressure is higher than the safe pressure, the equipment will stop immediately.

3) Cycle: set the cycle times and click “Cycle” to open the calculation function. Click the “Start” button to run the system. The equipment will stop when the calculation passes reaches its setting value.

4) Date: it can set the year, month, day, hour, minute, second. After completing the setting, please click “Date” to save the setting.

5) Forward and Backward: use for the manual position calibration, the maintenance or debugging.

6) Click “Back” to return to the previous menu.

6.5 Parameter Interface of Factory Setup

Contact the manufacturer for the information of the factory setup.

6.6 Varieties of Inlet and Outlet for MixGenizer

Inlet: Syringe; Open Container; Stainless Steel Cylinder

Outlet: Syringe; Open Container; Stainless Steel Cylinder

When circulation operations are needed for the testing material, please use a pipe to connect the Tri-clamp outlet into the top of the inlet syringe.



7. Trouble Shootings

7.1 Mechanical Trouble Shootings

7.1.1 Air-blocking and chamber-blocking or overload

Our design has minimized the occurrence of the air-blocking, chamber-blocking and overload. However, the improper operation of the



Instruction Manual MixGenizer Series

homogenizer can still induce the malfunction or damage to the homogenizer.

1) Air Blocking

Malfunction: There is no pressure or there is no sucking from inlet.

Prevention: Do not run with empty inlet.

Reason: There is air inside the pump.

Solution: Push the ball in the inlet valve with a pin.

2) Chamber Blocking

Malfunction: Overload of the pressure.

Prevention: Pre-treat the sample carefully; Reduce the speed.

Reason: There are aggregates or large particles in the sample; Or the equipment runs too fast.

Solution: Reverse the interaction chamber with water at low speed.

3) Overload

Solution: Reduce the speed and shut down the power, wait for 30 sec and restart again; or flush with water or suitable solvent; or run with clean and homo-disperse sample.

7.1.2 When the pressure is down:

1) Circuit Malfunction: check whether all the indicator lights are working well.

2) Malfunction of high pressure pump body: check whether the high pressure pump body is working well.

3) Malfunction of the inlet flow: check whether the one-way check valve is working well.

4) Leaking of the hydraulic system: check whether every joint is connected correctly.

7.1.3 When the high pressure pump sending out abnormal noise:

If the high pressure pump has foreign matters or serious abrasion, it should be returned to the factory for repair.

7.2 Trouble Shootings of Electric Appliance

7.2.1 The red switch of the power supply does not light on

- 1) If the fuse is blowout, please replace the fuse.
- 2) If the equipment is not connected with power supply, please connect it with the power supply.
- 3) If the outlet is not plugged well, please plug it again.

7.2.2 If the RUN light, COM light and the POWER light of the touch screen do not light on.

- 1) Please check whether touch screen is connected with power supply

or not.

2) If the touch screen is black out, please contact the customer service.

7.2.3 If the equipment does not work when pressing the green “Start” button, please turn off the power supply and restart it after **30 seconds**.

 The control systems need a few seconds for rebuilding. If the problem remains, please contact the customer service.

8. Maintenance

8.1 Cleaning

Please clean the equipment before turning off the system. Please use the solvent, alcohol or water in turn for flushing. Do not let the material stay for a long time, especially the viscous or indurate material.

 **Attention:** Service or maintenance work is prohibited when the system is running.

 **Attention:** Ensure that the pressure of the system has been released and the power supply has been turned off safely before implementing the service or maintenance work.



8.2 High Pressure Weep Holes

Some of the high pressure components have weep holes. Please check regularly whether the system is leaking or not, please turn off the equipment once leaking. Because the system is operating under the high pressure, even the little leakage would damage the sealing element in a few minutes.

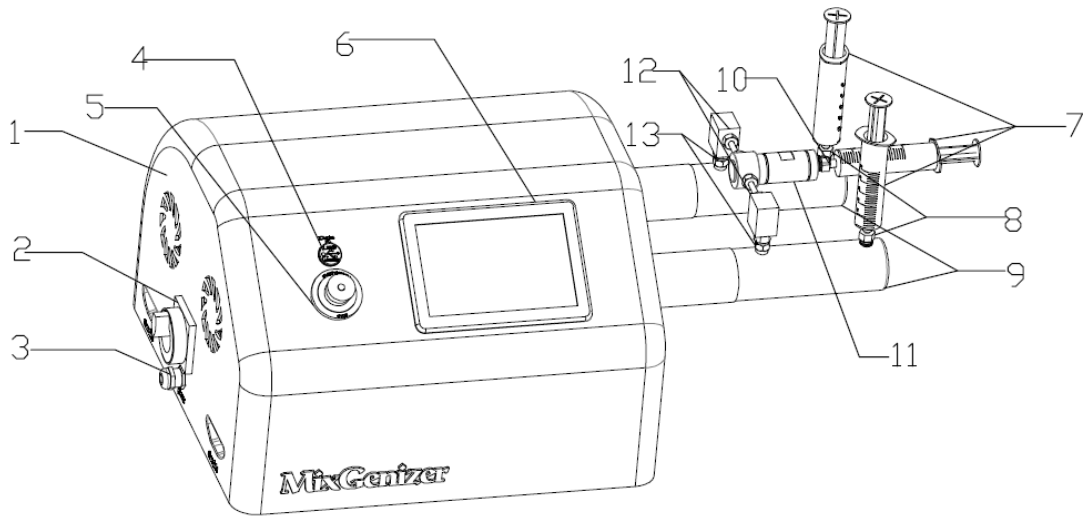

General Arrangement Drawing of MixGenizer

Components List			
Item	Component model	Quantity	Component name
1	MG-OS-3D	1	3D Printed Outer Shell
2	MG-PS	1	Power Supply
3	MG-PIC	1	Power Inlet Port
4	MG-USB	1	USB Port
5	MG-ES	1	Emergency stop
6	MG-PLC-TS	1	PLC Touch screen
7	MG-PS	3	Plastic Syringe
8	MG-CV-IN	2	Inlet Check Valve
9	MG-HPC	2	High Pressure Cylinder
10	MG-LF	1	Luer Fitting
11	MG-DIXC	1	Diamond Interaction Mixing Chamber
12	MG-EW	2	Elbow
13	MG-OCV	2	Outlet Check Valve



Instruction Manual MixGenizer Series

Extra parts: One set of disassemble & assemble tool unit for seal parts, two pieces of wrenches, two pieces of extra plunger seal, two pieces of extra fuse, two pieces of extra luer outlet hoses.

Remarks: the plastic syringes can be replaced by other containers (S/S Cylinder or glass container).

Note: 1. The specification, structure and parameter may be modified without notification.

2. The Dimensions, structure and parameter should be subject to the final product.